

Data Sheet

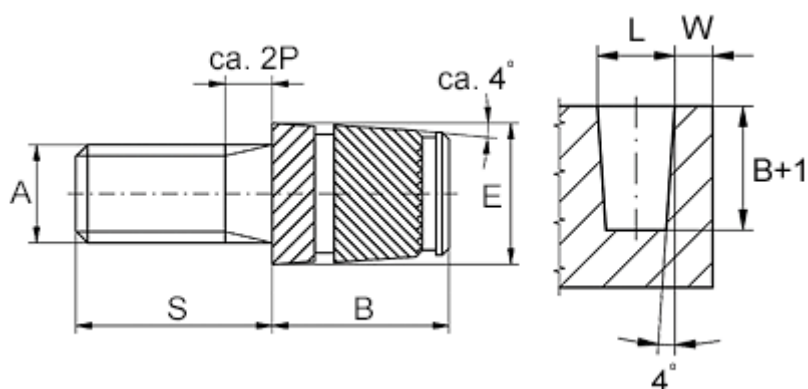

Article number: 12858100050840
Description: KLEE-coil 858 100 050.840
M5 Brass

Measures



Male thread A	= M5x0,8
Min distance to edge W	= 2.0
Mounting length B	= 9.0
Outer diameter E	= 7.2
Pin length S	= 10
Recommended bore diameter W +0.1	= 6.9